

ProClick Device Case S

Material no.: 6000015242 | Matchcode: PC GT S | EAN code: 4014599453563



- » Lockable bag for smartphones, etc.
- » With connecting cable opening on the underside
- » 2 additional loops for pens
- » Integrated strip loop for carabiners
- » Compatible with the entire ProClick system and the SR5 van racking

Materials & Colour

Material:	Polyester, high-grade steel, ABS, PA6
Colour:	Black, RAL 9017 Traffic black, Sortimo Blue

Dimensions

Outer dimensions:	210 x 120 x 50 mm
Interior dimensions:	160 x 90 x 20 mm
Usable area:	0.014 m ²

Technical data

Weight:	0,16 kg
Maximum load capacity:	5 kg

Conformity

REACH compliance:	EG 1907/2006
PAH compliance:	EU 1272/2013

ProClick Device Case S





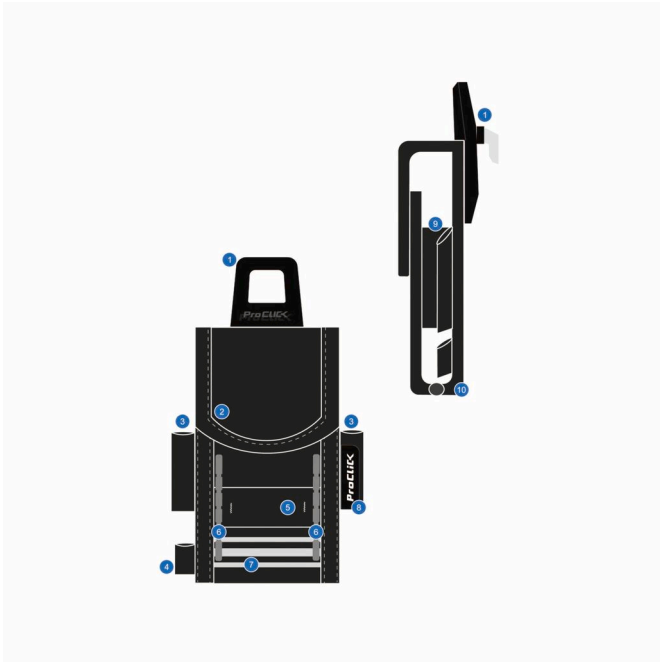

Material no.: 6000015242 | Matchcode: PC GT S | EAN code: 4014599453563

Design & Function



1. ClickUnit
2. Protective flap with Velcro fastener
3. Pen loops
4. Coil loop for carabiners
5. Rubber strip for the logo plate
6. Tube, long
7. Reflective safety strips
8. ProClick logo flag
9. Elastic rubber band
10. Recess for cable entry

Accessories

	Material no.	Description	Matchcode	EAN code
	6000013927	ProClick Holder	PC HOLDER	4014599386359
	6000013940	ProClick Tool Belt S, L=100cm	PC WKZG S	4014599386892
	6000013933	ProClick Tool Belt M, L=120cm	PC WKZG M	4014599386854
	6000013941	ProClick Tool Belt L, L=140cm	PC WKZG L	4014599386908
	6000015090	ProClick Toolbelt XL, L=160cm	PC WKZG XL	4014599076083
	6000014739	ProClick Unit Organizer, VPE 2 PCs.	PC UO VPE 2	4014599236418

ProClick Device Case S

Material no.: 6000015242 | Matchcode: PC GT S | EAN code: 4014599453563

Description

The ProClick equipment bag lets you securely store and transport your smartphone or other sensitive devices, like meters, on your body using the ProClick Holder or any other ProClick interface.

A connecting cable passes through an opening on the underside of the bag enabling you to charge your smartphone, etc. in the bag as well.

The interior dimensions of the bag are: 16 cm x 9 cm x 2 cm.

The ProClick Equipment Bag can be combined perfectly with the ProClick Holder on the tool belt. Now you always have your smartphone or meter to hand. The equipment bag can also be used as a smart storage system on all SR5 and Globelyst4 van racking system ProClick interfaces, as well as on mobile transport solutions, such as the C-BOXX, ProClick Tool Holder or AutoAssistant.

We reserve the right to make changes in the interest of technical progress, as well as correcting printing errors and mistakes. Pictures are similar, decorative material not included. With the publication of this data sheet, previous editions lose their validity. Version: 03.09.2025